

WALL DETAIL "W-1"

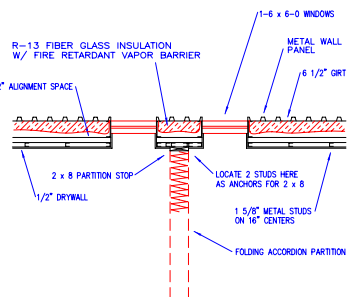

WALL DETAIL "W-2"

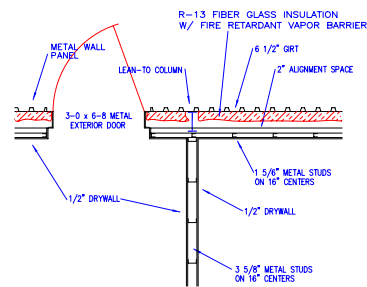

WALL DETAIL "W-3"

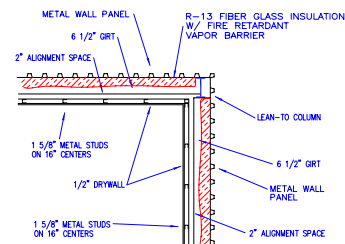

WALL DETAIL "W-4"

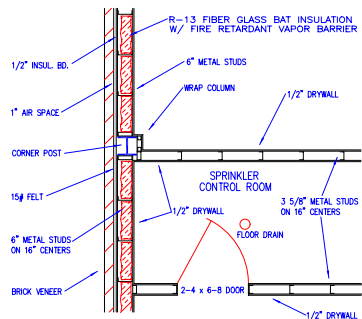

WALL DETAIL "W-5"

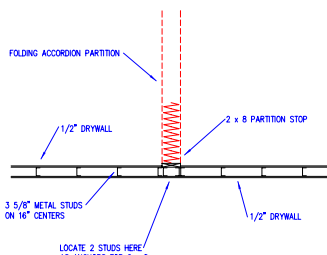

WALL DETAIL "W-6"

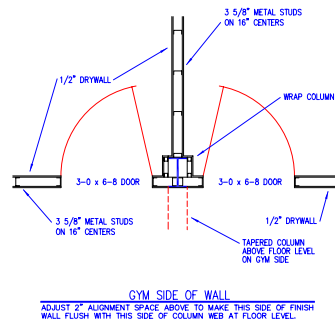

WALL DETAIL "W-7"

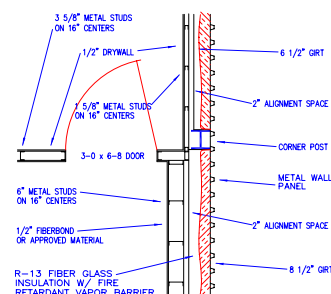

WALL DETAIL "W-8"

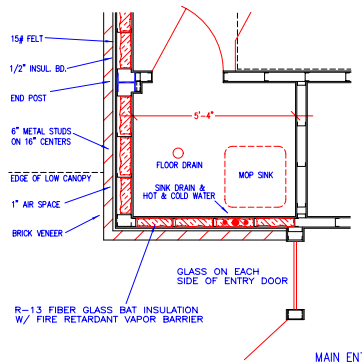

WALL DETAIL "W-9"

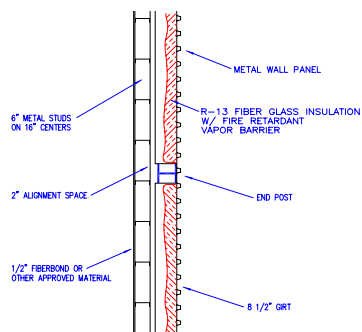

WALL DETAIL "W-10"

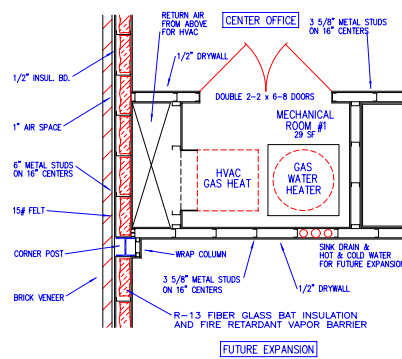

WALL DETAIL "W-11"

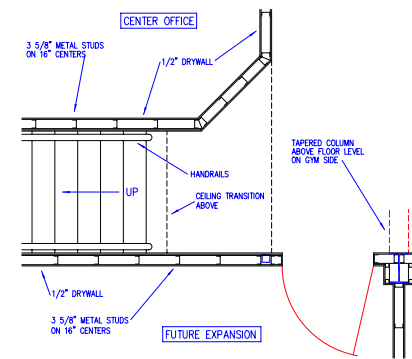

WALL DETAIL "W-12"

REVISIONS:

10/07/98	

Philip Kanter Associates, Inc.
 5866 SHADY GLEN ROAD - BOX 182-8419 OR 707-404-
 8419 - MEMPHIS, TN 38117
 SCALE: 1/2" = 1'-0"
 DRAWN BY: LEM
 CHECKED BY: PK
 DATE: 10/2/98
 APPROVED BY: PK
 DRAWING TITLE: WALL DETAILS
 DRAWING FILE NAME: A8-BBC.dwg

BRUNSWICK BAPTIST CHURCH
 FAMILY LIFE CENTER
 BRUNSWICK, TENNESSEE

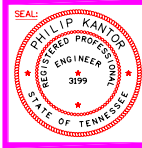

SHEET NUMBER:
A8

DESCRIPTION:
 E:\AUTOCAD\DWG\BCHURCH\NEW
 A8-BBC.DWG
 WALL DETAILS